

**Engineering Solutions**  
&  
**Industrial and Engineering Services**

for the  
Pharmaceutical, Cosmetics,  
Bio, Food and Chemical  
Industries



**KRIEGER**



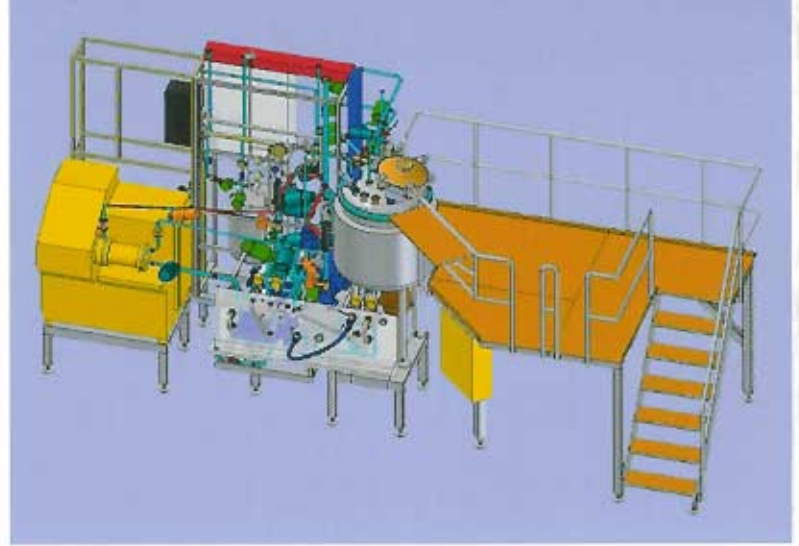

## About Krieger

Krieger represents over 50 years of experience and know how in the field of liquids and semi-solids processing. Our technology has made its way into many complete mixing & homogenising systems built to meet both individual customer requirements and the latest industry standards.

Krieger's aim is to provide solutions resulting in state-of-the-art mixing and homogenising systems. We therefore continuously improve our machines technically, thus guaranteeing top quality and high standard machines. In order to satisfy current and future technological as well as FDA, GMP, GAMP, CE and ISO requirements new developments are necessary. To achieve this goal we work in close cooperation with our customers.

One famous development is the Krieger counter rotating gear box with integrated (rotating) cleaning and sterilisation system. This integrated CIP/SIP system's design and process was validated and tested by major pharmaceutical multinationals around the globe to adhere to the stringent cleaning and sterilisation requirements of these industries.

Today, as a result of this development, all our mixing and homogenising machines are equipped as a standard or can be equipped with this gear box design, providing one single validated piece of equipment to handle different functions: mixing, homogenising, cleaning in place, sterilisation in place.

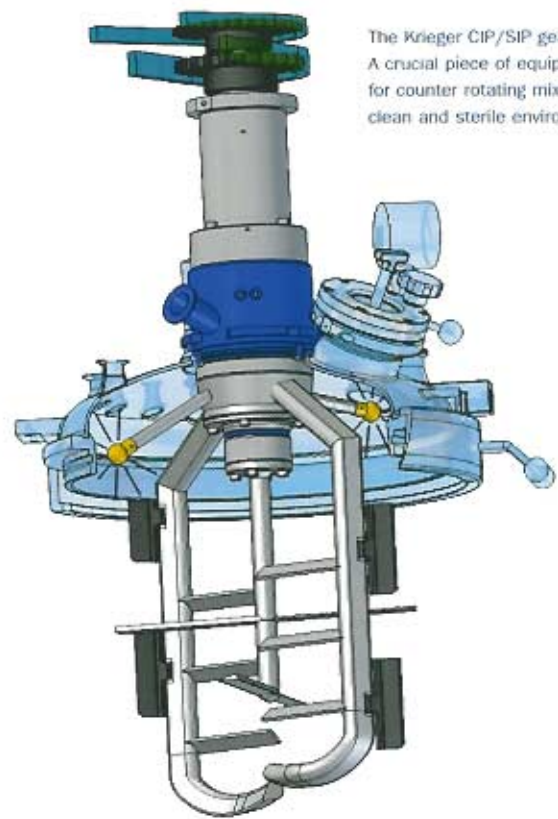

The Krieger CIP/SIP gear box. A crucial piece of equipment for counter rotating mixing in clean and sterile environments.

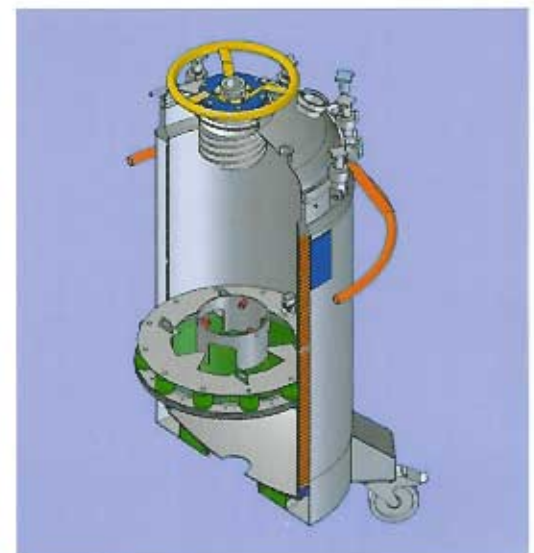
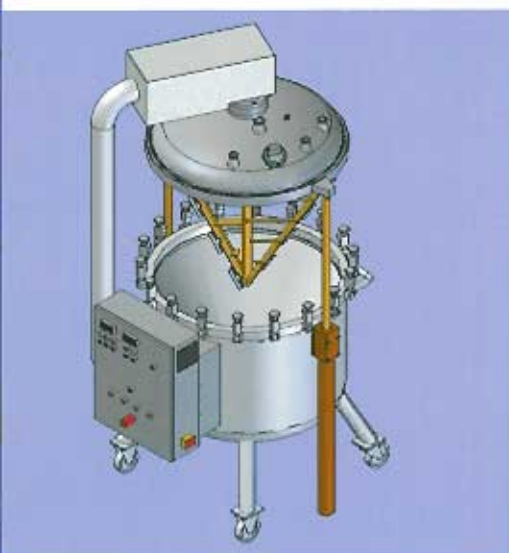



## Krieger Engineering Solutions

Customised equipment to handle your processes the way you would have designed them

Besides manufacturing our traditional mixing and homogenising systems, the Molto Mat and the K-Mix, Krieger has been very successful in designing special equipment for major pharmaceutical and cosmetics as well as chemical companies.

Our "Engineering Solutions" service offers customers the possibility to industrialise their process research findings to exactly suit their needs by working with a specialised partner: Krieger. Customers' processing research findings and technical requirements are taken into account during the design phase. This, combined with the Krieger know how in providing integrated Cleaning and Sterilisation in place systems result in turn key equipment that adheres to the most stringent GMP regulations of those industries. At start up a complete validation package is available.

Krieger engineering solutions have been of use to many major pharmaceutical and cosmetics companies including Novartis, Roche, Alcon and L'Oréal.

### Pictures Engineering Solutions:

- Integration of Micro & Nano wet grinding mills
- 3D design of sterile ointment transfer tanks
- Contained processes for toxic ingredients
- 100% pure mixing chambers for pure products

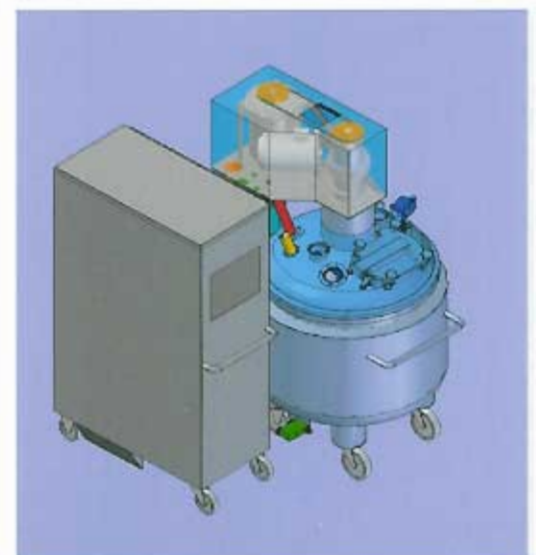
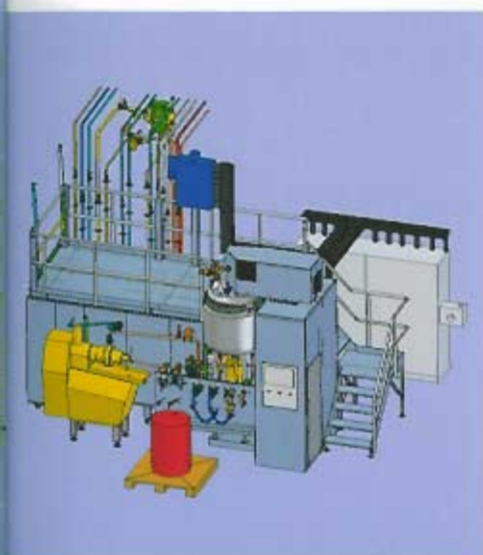



Orbital welding with certificate



Welding of utility connections



Calibration and IQ/OQ validation

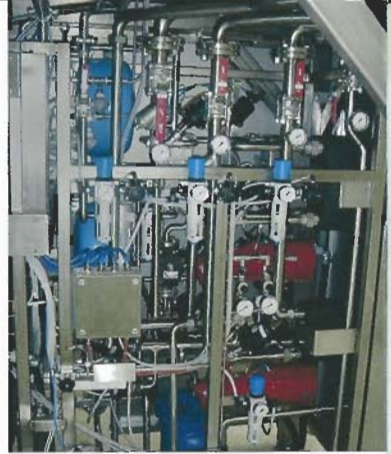

Design on customer demand

## Krieger Industrial and Engineering Services

Let our international team master and speed up your start ups.

As a result of our experience in installing and commissioning our turn key equipment at various pharmaceutical and cosmetics customers, Krieger has an excellent ability to service existing installations and to assist with a wide variety of commissioning tasks. Today, both individual customers and international process equipment manufacturers rely on Krieger for installation work and commissioning, including software start ups in the field.

### **Krieger provides you with the following services:**

#### **Engineering:**

- Software programming according to Gamp 4 rules
- Start up of software in the field
- IQ/OQ validation
- Mechanical and electrical design on customer demand
- Calibration

#### **Installation & Support:**

- Orbital welding with certificate
- Stainless steel piping welding of utility connection
- Electrical, pneumatic wiring of installations
- Service of existing installations

Technical cooperation:



Small Scale Processing Equipment



Micro & Nano Wet Grinding

Service cooperation:



Service for Asia



**KRIEGER**  
**Mixing & Homogenising Systems**

Frohburgerstrasse 25

CH-4132 Muttenz

Phone: 0041 61 465 39 00

Fax: 0041 61 465 39 19

e-mail: sales@kriegerswitzerland.com

www.kriegerswitzerland.com